

OIF-FEC-100G-01.0
100G Forward Error Correction White Paper
(May 2010)

1 Executive Summary

Network operators forecast a long term trend of rapid traffic growth that demands the network capacity to be doubled approximately every 12-18 months. Given the increasing network traffic load, there is an urgent need to increase the network capacity from 10 Gigabit per second (Gb/s) per channel to 40Gb/s and now 100Gb/s per channel in the same optical channel bandwidth. When compared with all viable solutions, Forward Error Correction (FEC) is commonly considered as an attractive cost-effective candidate to recover the lost sensitivity due to the transition to higher data rates.

Recognizing the industry's demand, the OIF authorized the PLL WG to investigate FEC for its use in 100G DP-QPSK DWDM long distance communication, with a key objective to suggest an upper bound for the spectral overhead due to FEC coding¹. The upper bound was useful in determining the upper bandwidth requirement for the OIF's integrated photonics projects. This white paper summarizes the OIF's investigation of

¹ The OIF's 100G LH DWDM Framework document can be found at <http://www.oiforum.com/public/documents/OIF-FD-100G-DWDM-01.0.pdf>

FEC for use with 100G DP-QPSK in long distance DWDM communications and suggests an upper limit for spectral coding overhead.

2 Introduction

The mission of the Optical Internetworking Forum (OIF) is to promote the development and deployment of interoperable networking solutions and services for optical networking products, network processing elements, and component technologies. The Physical and Link Layer Working Group (PLL WG) develops Implementation Agreements and White Papers related to physical and data link layer interfaces between Optical Internetworking elements and between their internal components, and leverages existing standards whenever applicable.

Preparing to meet industry's demand, the PLL WG has completed a 100G long-distance DWDM transmission framework project that documents high-level system objectives for initial implementations of 100G long-haul DWDM transmission systems. It identifies a transceiver module functional architecture, and decomposes it into a number of technological building blocks.

The OIF authorized the PLL WG to investigate FEC for its use in 100G DP-QPSK DWDM long distance communication, with a key objective to suggest an upper bound for the spectral overhead due to FEC coding. The upper bound was useful in determining the upper bandwidth requirement for the OIF's integrated photonics projects.

3 **Project Overview**

Network operators project a long term trend of traffic growth at a rate of over 75% per year, which in turn requires the capacity to be doubled approximately every 12-18 months [Nowell 07]. Given the current network traffic load and growth rate of the operators, there exists an urgent need to increase the network capacity through improvements in spectral efficiency. This can be accomplished by launching 100Gb/s per channel instead of 10Gb/s over 50GHz spaced channels.

One of the most cost effective architectures is to deploy 100Gb/s systems utilizing existing 10Gb/s infrastructure. Long distance DWDM communication systems are typically limited by optical signal-to-noise ratio (OSNR). Unfortunately, a straight forward 10x increase in the data rate over an existing channel results in a 10x reduction in OSNR. Closing this significant performance gap between the two systems requires a 10x improvement in OSNR for 100Gb/s implementations. There are several techniques that can be used to reduce the OSNR deficit such as through DP-QPSK modulation in conjunction with a coherent receiver. However, even after taking advantage of all these techniques, a significant OSNR deficit remains. The OSNR gap must be closed in order to achieve the objective of transmitting 100Gb/s over existing 10Gb/s infrastructure.

Among the available technologies to further improve the OSNR deficit, FEC solutions are typically the most cost-effective. Figure 1 shows the performance of commercially available standardized FEC solutions against the theoretical maximums given by the Shannon limits.

Additional technologies, such as more advanced optical filters and additional OEO inline regenerators can be employed to provide further OSNR improvements.

The objective of the OIF's FEC project is to maximize the FEC gain by specifically investigating Forward Error Correction (FEC) and by suggesting an upper limit for spectral coding overhead while taking into account dual-polarization quadrature phase-shift keying (DP-QPSK) in conjunction with a coherent receiver.

This white paper summarizes the OIF's investigation of FEC for use with 100G DP-QPSK long distance DWDM communications.

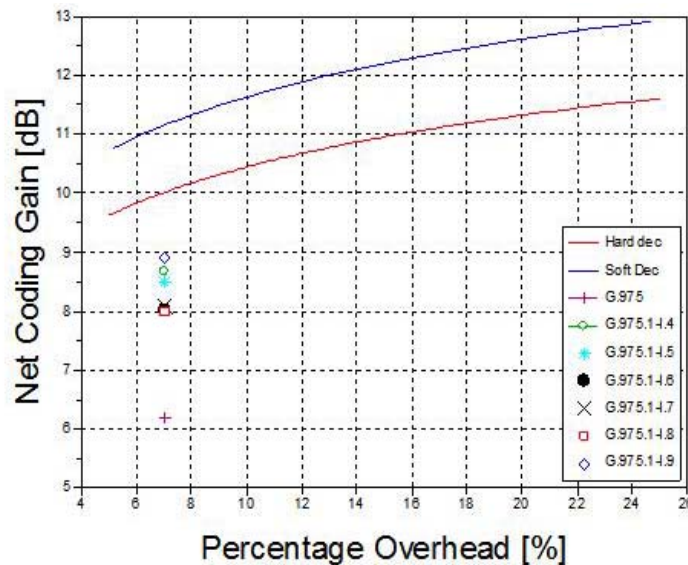

Figure 1 Comparison of NCG for Standardized FECs against the Shannon Limits

4 FEC for 100G DWDM LH Communication

4.1 Metrics

FEC encoders generate redundant information that is transmitted with the data. At the receiver, the redundant information can be used to correct errors in the data which may have occurred. A key metric is the *coding overhead rate* is the ratio of the numbers of redundant bits (r) and information bits (k), i.e., $OH = r/k$ and can be expressed as a percentage.

Another important metric of an FEC code is the NCG, whose expression in a binary additive white Gaussian noise (AWGN) channel is given by

$$NCG(dB) = 20\log_{10}[erfc^{-1}(2BER_{ref})] - 20\log_{10}[erfc^{-1}(2BER_{in})] + 10\log_{10} R$$

where BER_{ref} and BER_{in} are, respectively, the reference output bit error ratio (BER) and the maximum allowable input BER of the signal input to the FEC decoder [Mizuochi 06], and the function $erfc(\cdot)$ is the complementary error function. Further, the term $+10\log_{10}R$ with $R = k/(k+r)$ represents the penalty due to the fact that a fraction of the total signal energy is now spent for the redundant coding overhead and is missing for the information bits².

4.2 Hard and Soft Decision Forward Error Correction

In assessing the performance of an FEC code, one typically compares its NCG against the Shannon Limit which represents the theoretically achievable performance. Figure 2 shows the Shannon Limits for both hard-decision (HD) and soft-decision (SD) decoding algorithms at different overhead rates in an AWGN channel [Cai 05].

² BER can be defined as $\frac{1}{2}erfc\left(\frac{Q}{\sqrt{2}}\right)$ as described in "ITU-T Recommendation G.975.1" and leads to an alternative expression for NCG of $20\log_{10}[Q_{ref}] - 20\log_{10}[Q_{in}] + 10\log_{10} R$

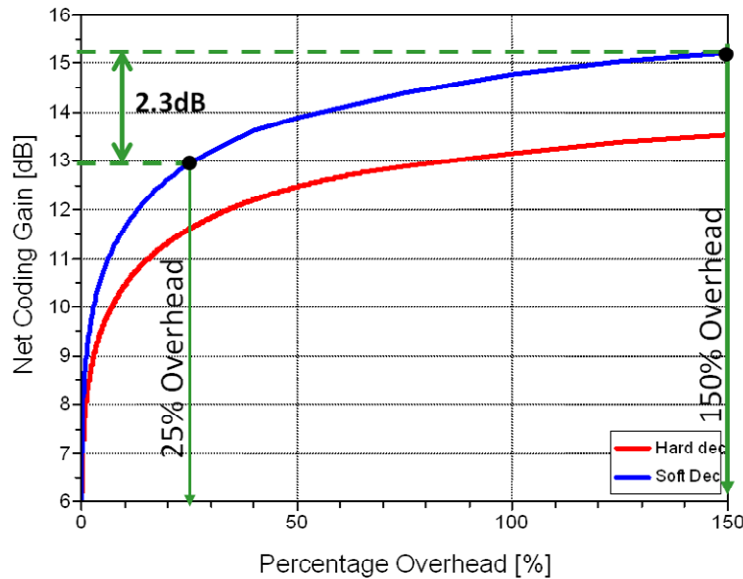

Figure 2: The Shannon Limit - Maximum Theoretical NCG [Cai 05]

The difference between the HD and SD algorithms lie in the number of input bits required for decoding. A hard-decision decoder makes a firm decision on whether a “1” or “0” is transmitted and provides no other information to the decoder. Hence, its output is quantized only to two levels, namely “1” and “0”. On the other hand, a soft-decision decoder is provided with additional information so as to indicate the reliability of a decision. In other words, its output is quantized to more than two levels such that the result is not only the bit “1” or “0”, but also the confidence level of this decision. In reference to the figure and the selected results elaborated in Table 1, it can be observed that SD decoding generally outperforms the HD counterpart and the performance improvement increases with the coding overhead. For an ideal scenario with 25% overhead, an additional gain of 1.3dB can be theoretically achieved when SD decoding is used in place of HD decoding.

In actual implementations, the additional gain achieved by replacing HD decoding with iteratively SD decoding is much smaller. At 7% and 25% OH, for example, the gain difference is about 0.5dB and 0.9dB, respectively. The

NCG improvements should be balanced against the increases in complexity, latency, and power consumption associated with the use of SD-FEC. The performances of selected HD and SD FECs are shown in Appendix A for reference.

Overhead	HD	SD	Additional NCG (HD→SD)
7%	10.00dB	11.10dB	1.10dB
15%	10.95dB	12.20dB	1.25dB
25%	11.60dB	12.90dB	1.30dB

Table 1 Shannon’s Theoretical Limits for HD and SD decoding algorithms

4.3 Impact of Increasing the Spectral Coding Overhead Rate

Although increasing the coding overhead rate increases the NCG, it is worth noting that an increase in overhead rate results in spectral width broadening, which in turn introduces additional passband narrowing penalty (PBN) due to signal clipping with the presence of ROADMs. The additional penalty reduces the achievable coding gain from a line system perspective.

Considering a channel spacing of 50GHz and OSNR of 16dB (assuming 0.1nm noise resolution bandwidth), an illustrative example is given in Figure 3, that depicts the Q-penalty against different numbers of third-order Gaussian ROADM filters, each of which has 40GHz FWHM (Full Width at Half Maximum) bandwidth. It can be clearly seen that after 5 cascaded ROADMs, the PBN penalties for both NRZ-aligned and RZ-interleaved DP-QPSK signals are about 1dB, if the overhead rate increases from 7% to 25%.

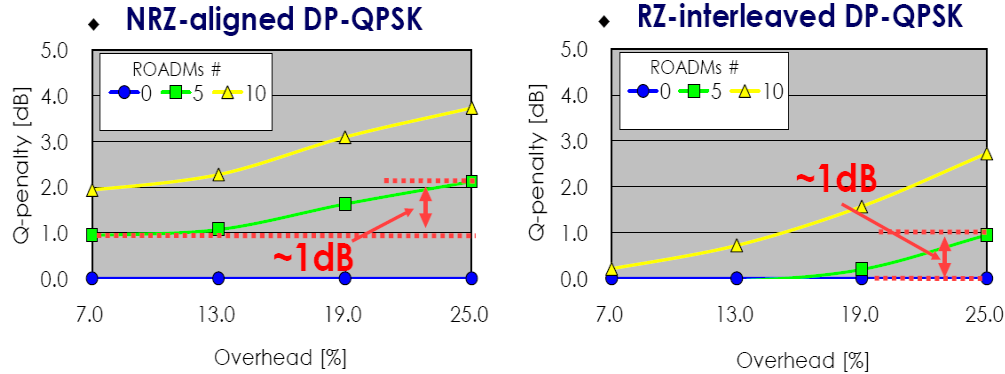

Figure 3 Impact of ROADM impairment in absence of equalizer.

4.4 Modeling PBN

In order to predict the impact of PBN due to ROADM filters on NCG for various overhead rates, an accurate link model becomes desirable. However, detailed link models would be specific to a particular optical line implementation and hence would not be representative across various implementations.

A relatively implementation-independent link model suitable for estimating relative performance was developed and used to benchmark key technical choices against each other. The model is not designed to represent any particular link and the results obtained may be pessimistic or optimistic compared to practical system implementations. Such a model can be shared without disclosing proprietary information.

A generic link model diagram is shown in Figure 4 and the corresponding model parameters are detailed in Appendix A. Our goal is to include just the key effects in a simplified link model to estimate the relative performance. It is important to note that any model parameters mentioned are not an accurate representation of an actual system and those parameters can vary greatly from system to system, and depend on actual system architecture.

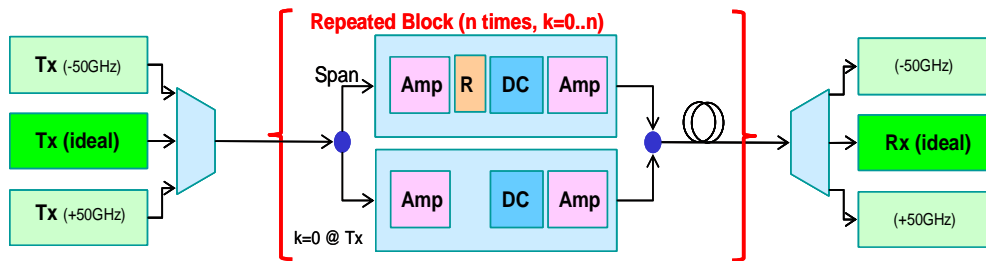

Figure 4 Generic Link Model

Two kinds of impairments must be modeled to assess the impact of increased overhead rate on OSNR. One is PBN due to the presence of optical filters. The second is due to a decrease in SNR at the receiver as the receiver bandwidth is increased to adapt to an increased coding overhead rate. Impairments due to polarization mode dispersion (PMD) and chromatic dispersion (CD) can be ignored due to assumed presence of an “ideal” equalizer³. Note that the use of an equalizer in the receiver can also overcome some of the PBN impairments and therefore, is included in the model. To avoid choosing a specific equalizer implementation, an implementation independent ideal equalizer is included in the simplified link model. As to other impairments, such as channel crosstalk from directly adjacent channel traffic and other non-linear effects, they were assumed to be second order effects and were ignored for simplicity when assessing the relative performance of the various coding overhead rates.

Even with these simplifications, the link model still contains a number of implementation specific parameters. To avoid this and yet still make relative performance tradeoffs, the link model was further simplified by lumping the relative losses in a non-implementation specific manner as shown in Figure 5.

³ An ideal equalizer is defined as one that fully equalizes the received signal without the addition of noise.

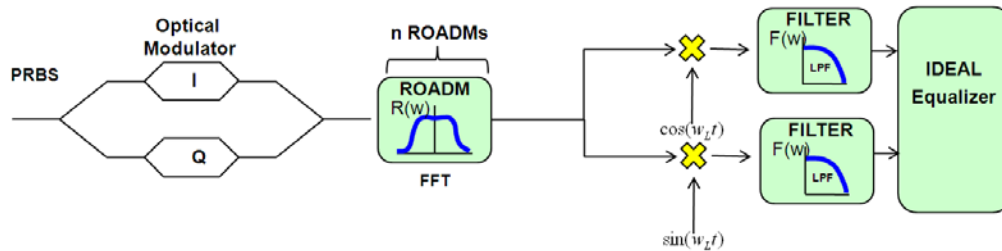

Figure 5 Simplified Link Model

4.5 Determining an Upper Bound for Spectral Coding Overhead

The impact of increasing the FEC coding overhead is dependent on the link assumptions, including the number of ROADM filters and their respective bandwidth. A number of scenarios were modeled. After taking into account the Q-penalty due to ROADM impairments and the coding gain predicted the Shannon Limit, the NCGs for both HD and SD peaks at about 12-14% OH at the absence of any equalizers as shown in Figure 6.

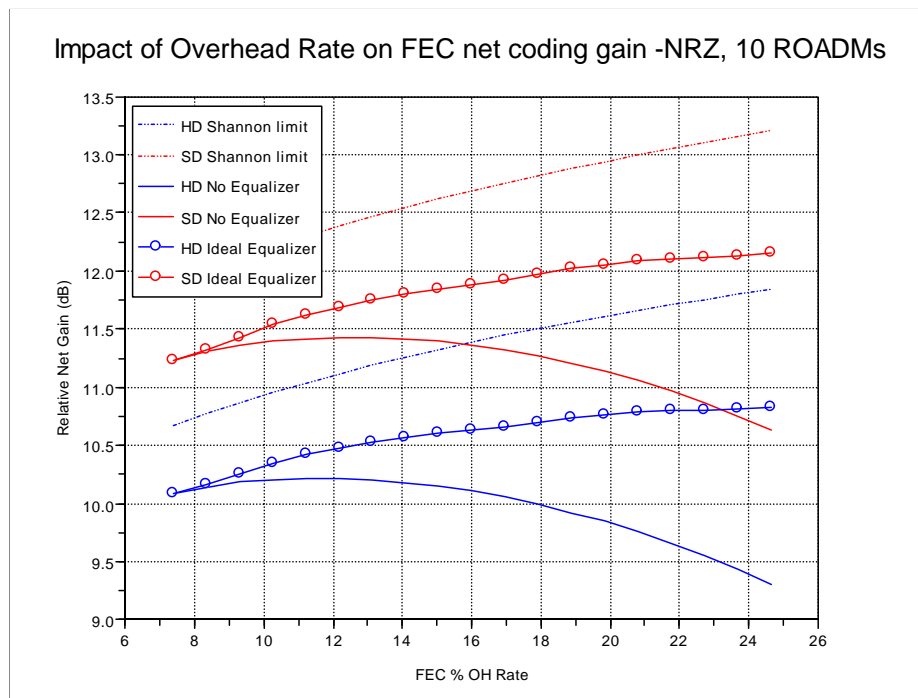

Figure 6 Relative NCG with and without equalization for NRZ

However, when an ideal equalizer is included in the receiver model, the PBN effects are partially compensated which results in the NCG flattening out with the increase overhead are also shown in Figure 6. Note that the specific case shown in the figure should provide a reasonable upper bound given it includes ideal equalizers and 10 ROADMs. A 20% FEC coding overhead rate was chosen as a practical upper limit based upon relatively small increase in NCG possible with overhead rates greater than 20% even when ideal equalizers are employed. Non-idealities would push the practical maximum to lower coding overhead rates. For example, Figure 7 shows that the NCGs for both ideal HD and SD FEC codes peaks at only 9.5% OH for the given scenario.

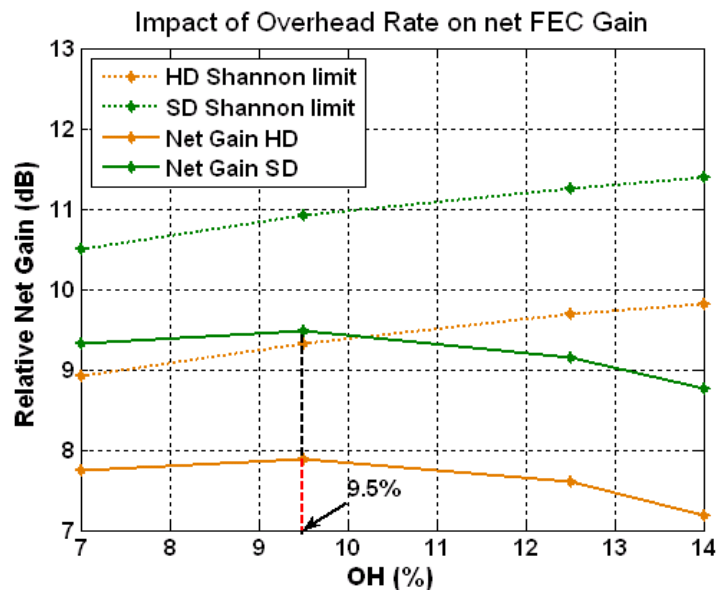

Figure 7 Net coding gain versus percentage overhead with equalization for NRZ for a particular scenario.

Although a higher price needs to be paid when using higher coding rates, the increased OSNR may be necessary and economical in certain long-haul or ultra long-haul communications. A systemic method of computing the

NCG of a candidate FEC solution for a certain transmission distance network can help make an appropriate choice.

4.6 Implementation Considerations

Figure 8 shows the transceiver module functional architecture of a 100Gb/s DWDM long-haul communication system.

Implementations using a 7% coding overhead may place the FEC either inside or outside of the module since the high speed electrical data interface can support data rates up to a 7% coding overhead. In addition, FECs using 7% overhead or less tend to use HD implementations given the relatively small additional coding gain for SD FEC over HD FEC when compared to the increased implementation complexity.

Implementations with coding overhead rates exceeding 7% need to locate the FEC inside the module due to the bandwidth limitations of the module's data interface. In other words, there would not be an exposed interface between the FEC and the DSP.

Practical SD-FEC implementations would require an interface capable of transferring soft information at coding overhead rates exceeding 7%. The corresponding data interface would require more bandwidth at the module interface than is available given the current technologies and standards. As a result, there can't be an exposed interface between the SD-FEC and the DSP.

Therefore as shown in Figure 8, a higher coding overhead *optional* FEC (SD-FEC or HD-FEC) is shown within the module.

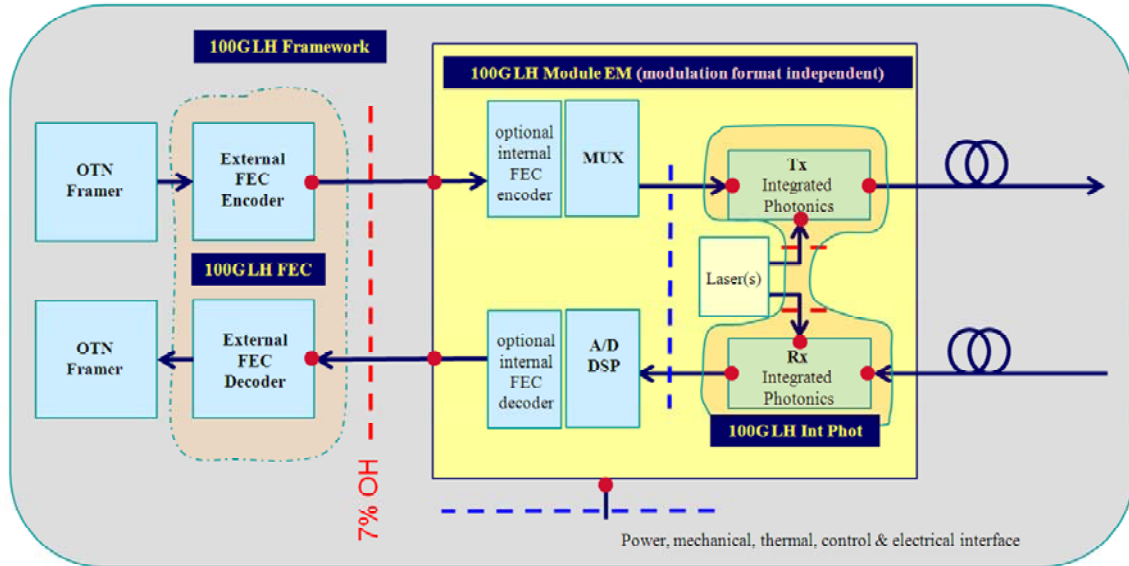

Figure 8 100G DP-QPSK Transceiver module functional architecture with enhanced FEC.

5 Summary

The move to higher data rates with advanced modulation techniques results in an OSNR deficit as compared to 10G transmission over the existing 10G fiber links. FEC is an attractive cost-effective solution to help close the OSNR deficit. However, the standardized 10G FECs at a 7% coding overhead rate are not sufficient to achieve the required FEC gain. Therefore, higher NCG resulting from higher coding overhead rates is inevitable and has been investigated in this white paper.

Recognizing the industry's need, OIF had initiated a project to study enhanced FEC for use together with 100G DP-QPSK modulation in conjunction with a coherent receiver for long distance DWDM optical communications. This white paper summarizes the OIF's investigation of FEC for use with 100G DP-QPSK in long distance DWDM communications and suggests an upper limit for spectral coding overhead for the OIF's integrated photonics components projects.

The upper limit for the coding rate depends on a number of factors. In order to avoid implementation specific models, a simplified implementation independent link model was created using ideal equalizer, receiver and transmitter to help understand the impact of increase coding rates on OSNR of a line system. Two key effects were identified, namely passband narrowing and increased noise at the receiver due to increased coding rate. Other effects have been ignored due to the use of an ideal equalizer. A spectral coding overhead rate of 20% is suggested as a reasonable upper limit for use by the OIF's integrated photonics projects.

This paper is the collaborative effort of many members of the OIF, including:
Edward Au, Huawei Technologies
Francesco Caggioni, AMCC
Jeff Hutchins, CoreOptics

6 **Reference**

- [Nowell 07] M. Nowell, V. Vusirikala, and R. Hay, "Overview of requirements and applications for 40 Gigabit and 100 Gigabit Ethernet," *Ethernet Alliance White Paper*, August 2007.
- [Cai 05] Yi Cai, "Limit on coding and modulation gains in fiber-optic communication systems," in *Proceedings of Wireless and Optical Communications Conference*, New Jersey, United States, April 2005.
- [Mizuochi 06] T. Mizuochi, "Recent progress in forward error correction and its interplay with transmission impairments," *IEEE Journal of Selected Topics in Quantum Electronics*, vol. 12, no. 4, pp. 544-554, July/August 2006.

7 Appendix A: Performance of Selected HD and SD FECs

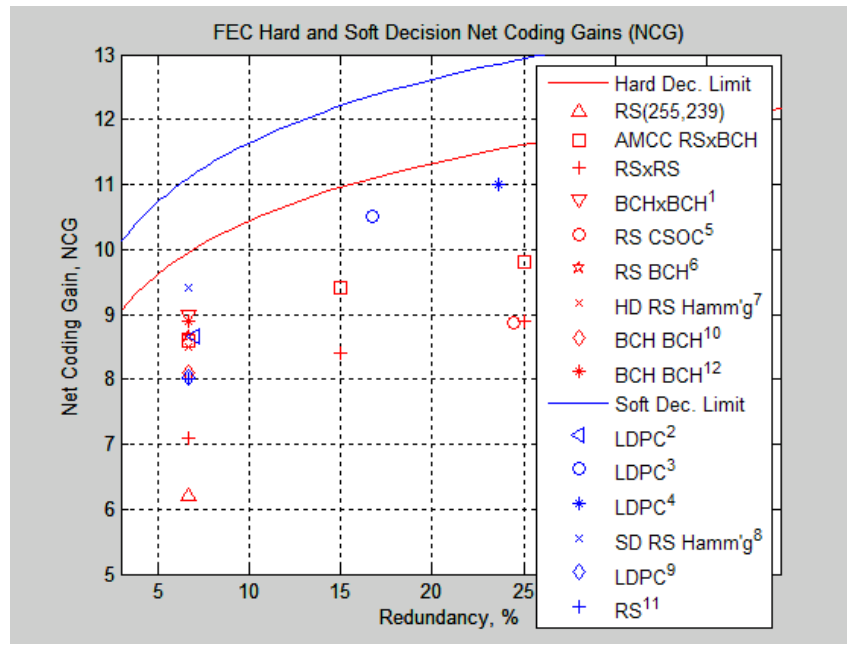

- 1 Concatenated BCH codes: outer code: BCH(3860,3824), inner code: BCH(2040,1930), 7% OH, 8.99dB NCG, 3 iterations, G.975.1 I.3 code
- 2 LDPC code (32000,29759), 7% OH, 8.56dB NCG, 50 iterations, OWE7 OFC 2007.
- 3 LDPC (8148,6984), 16.67% OH, 11.3dB NCG @1e-8, 16 iterations, OWE5 OFC 2007.
- 4 LDPC (3639,3213), 23.6% OH, 10.9dB NCG @ 1e-13, projected 11.3 dB @ 1e-15.
- 5 RS(255,239) outer, CSOC (n/k=7/6,J=8) inner, 24.48% OH, 8.88dB NCG @1e-15, G.975.1 I.2 code
- 6 RS(1023,1007) outer, BCH(2047,1952) inner, 7% OH, 8.67dB NCG @ 1e-15, G.975.1 I.4 code
- 7 RS(1901,1855) outer, Ext Ham. (512,502)x(510,500) inner, Hard D, 7%OH, 8.5dB NCG @ 1e-15, G.975.1 I.5 code
- 8 Above code: decoded with 8 iterations and 2-bit soft decision, 7% OH, 9.4dB NCG @ 1e-15, G.975.1 I.5 code
- 9 LDPC (32640,30592), 7% OH, 8.02dB NCG @ 1e-15, num of iterations NK, G.975.1 I.6 code

- 10 row/column orthogonal concatenated BCHs, 7% OH, 8.09dB NCG, 2.5 iterations (row,col,row.. decoding), G.975.1 I.7 code
- 11 RS(2720,2550), 7% OH, 8 dB NCG @ 1e-15, G.975.1 I.8 code
- 12 Two interleaved BCH(1020,988), 7% OH, 8.9dB NCG @1e-15 10 iterations, G.975.1 I.9 code

8 Appendix B: Link Model Parameters

8.1 Ideal Transmitter

The following information is required for transmitter modeling.

- a) Adjacent traffic format and the corresponding power
- b) Power level (unit: dBm/channel)
- c) Mux

Insertion loss (unit: dB)

FWHM and its shape

- d) Amplifier

nf

Further, it is assumed that the transmit OSNR is infinity.

8.2 Transmission Link

To model the transmission link, the following parameters are required.

- a) Number of Spans (n)
- b) Span fiber and DC
 - Length (unit: km)
 - Losses (unit: dB/km)
 - Dispersion map
 - First-order dispersion coefficient
 - Non-linear coefficients (such as xpm, spm)
 - Input power (unit: dBm/channel)
- c) Amplifier
 - nf per amplifier
- d) ROADMs (R)
 - Number of ROADMs and their locations
 - Insertion loss (unit: dB)
 - FWHM and its shape

8.3 Ideal Receiver

The following information is required for modeling an ideal receiver.

- a) Optimal eye sampling location
- b) DE-MUX
 - Insertion loss (unit: dB)
 - FWHM and its shape
 - Input power (unit: dBm/channel)

Further, perfect equalization is assumed.

9 Appendix C: Computation on NCG of a FEC for a Certain Transmission Distance

Application scenario with different transmission distances is an important factor to decide either HD-FEC or SD-FEC is applied. In the following, a systematic method of computing the NCG of a candidate FEC code based on a given supported reach is presented.

In a system with a cascaded optical amplifier chain with $N_{span} - 1$ line amplifiers, the OSNR at the input of the receiver is

$$\text{OSNR (dB)} \approx P_{out} - \text{Span Loss} - \text{Noise Figure} - 10 \log(N_{span}) - 10 \log(h\nu v_r)$$

where P_{out} (dBm) is the output power of the booster and the line amplifier, span loss is assumed to be equal to the gain (in dB) of the line amplifier, h refers to Planck's constant, and ν and ν_r are optical frequency and reference bandwidth, respectively.

Consider an OSNR penalty of about 5 - 5.5dB, which consists of channel impairments of 2dB, channel OSNR margin of about 2.5 - 3dB, and receiver aging margin of 0.5dB. Based on the launched power against BER curve, and the OSNR margin against BER curve of a back-to-back BER system, the maximum allowable input BER of the signal input to the FEC decoder, i.e., BER_{in} , can be obtained. Then, the NCG can be derived as follows.

$$NCG(\text{dB}) = 20 \log_{10}[\text{erfc}^{-1}(2BER_{ref})] - 20 \log_{10}[\text{erfc}^{-1}(2BER_{in})] + 10 \log_{10} R$$

Advanced FEC technologies can be used to achieve the required NCG.